

UPS TO PROTECT POWER SUPPLY OF DATA CENTER

INTRODUCTION

The protection of Data Center through static uninterruptible power supplies is essential to ensure continuity of the power supply and prevent damage caused by voltage and frequency anomalies.

The simple supply of electricity is not enough to guarantee the continuity of operations of a Data Centre which, if not adequately protected with UPS systems, is subject to operational interruptions due to voltage drops, various types of inefficiencies, or worse blackouts, which can also lead to information and data losses, with serious economic consequences.

UPSs (uninterruptible power supplies) are devices that manage electricity: they accumulate it, store and deliver it as needed, in a controlled and safe way. They are essential in critical applications because they ensure:

- **power quality** (perfect sinewave and clean waveform)
- **continuity** of service (the load doesn't stop in case of a blackout)

- **flexibility** (they deliver the energy required when required).

A quality flow of electricity is essential for the operation of each plant. Unfortunately, this flow is subject to many types of disturbances, including voltage variations (Fig. 1), waveform distortions (Fig. 2), interruptions (Fig. 3), frequency variations (Fig. 4).

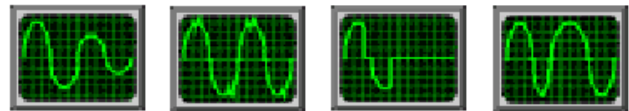

Fig. 1

Fig. 2

Fig. 3

Fig. 4

In Data Center, these impurities, together with blackouts, are particularly dangerous as they are responsible for most of the inefficiencies, with very severe consequences (loss of data, breakdowns, interruption of services and higher energy costs). The solution lies in the adoption of UPS capable of ensuring a continuous, clean, perfectly sinusoidal power supply. (Fig. 5)

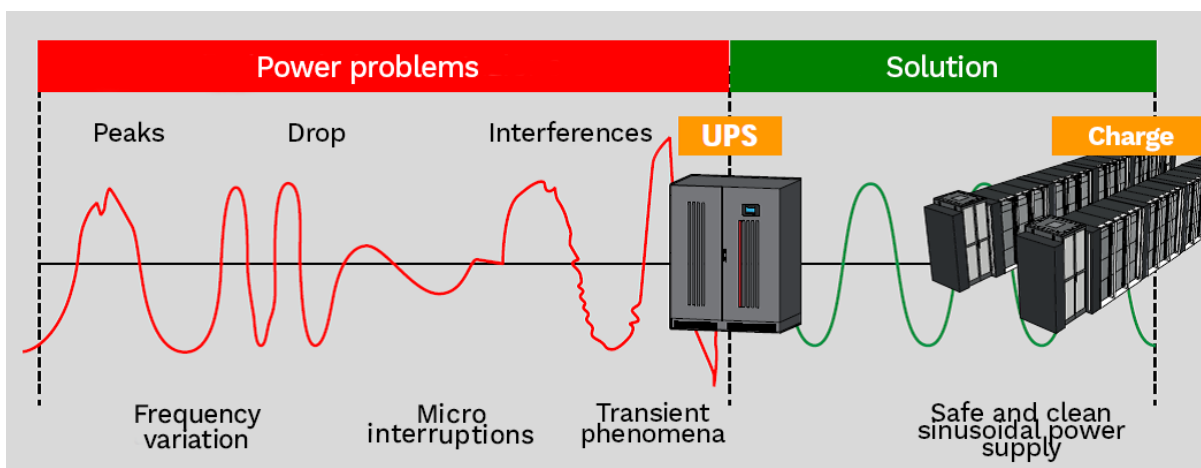

Fig. 5

EVALUATION CRITERIA FOR CHOOSING THE RIGHT UPS FOR THE DATACENTER

UPS classification

	Electrical phenomena	Time	e.g.	IEC	UPS Solution
1	Outages - blackouts...	>10 ms		VFD TYPE	Classification 3 OFFLINE
2	Voltage drop			VFD	
3	Dynamic surges			VI	
4	Sags	Continue		VI	Classification 2 Line Interactive
5	Surge				
6	Discharges	Sporadic		VFI	Classification 1 ONLINE
7	Transients (overvoltages)	>4 ms			
8	Frequency variations	Sporadic			
9	HF voltage distortion	Periodical			
10	Harmonic voltages	Continue			

The criticality of the application and the power ratings involved, require the use of uninterruptible power supplies equipped with double conversion technology (VFI) (Voltage-Frequency Independent). In this design, output voltage and frequency are independent of the input voltage and frequency.

When the AC input does not fall within the preset tolerances of the UPS, this enters the battery operation mode. In battery operation the battery/inverter combination continues to support the load until the stored energy is exhausted (autonomy), or until the power returns to within the tolerances allowed by the UPS.

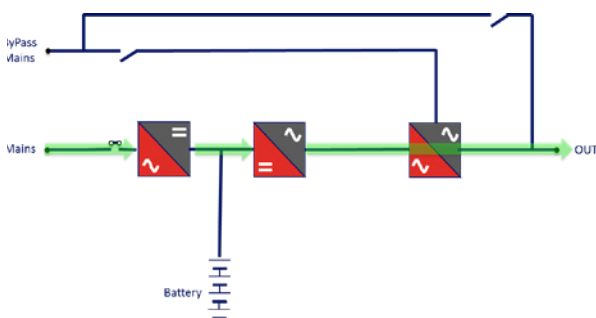

In normal operation, the load is powered continuously by the rectifier / inverter combination with a double conversion structure, i.e. a.c. - c.c. - c.c - c.a.

Electrical sizing

In evaluating the UPS power, it is necessary to consider:

- The power of the critical load to be supplied, both as apparent power and as active power.
- The nature of the critical load to be fed.
- If it is necessary to add other types of service loads to the critical load (e.g. air-conditioning).
- Nature of the service loads (e.g. motors, compressors, ...).
- Future growth margin of critical load and service loads.

Typology of architecture

The Uptime Institute classifies Data Center installations according to the increasing availability and resilience to failure and downtime. We can use this classification system to evaluate the correct UPS system for each Data Center installation.

	Tier I	Tier II	Tier III	Tier IV
Distribution paths	Only 1	Only 1	1 Active 1 Passive	2 Active
Distribution/redundancy paths	N	N+1	N+1	S+S or 2(N+1)
Compartmentalization	No	No	No	Yes
Contemporary maintainability	No	No	Yes	Yes
Fault tolerance	No	No	No	Yes

Single power supply network (Fig. 9)

- Susceptible to outages due to planned and unplanned activities;
- Lack of redundancy, with a single power supply and cooling system;
- The presence or not of UPS, generators and floating floor;
- Total shutdown during preventive maintenance.

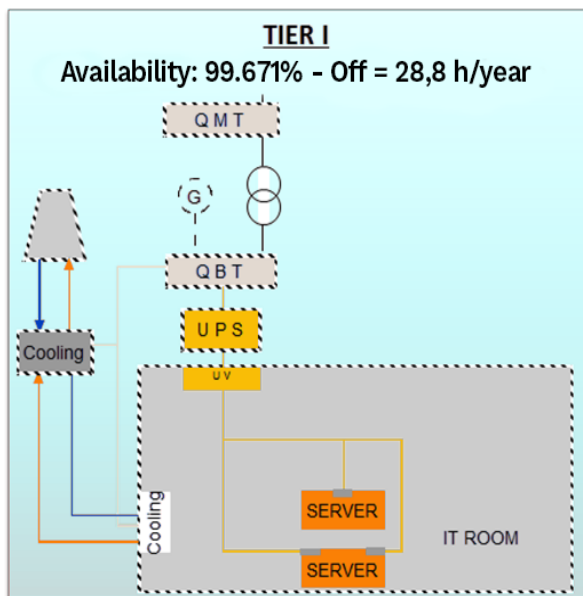

Fig. 9

Network with redundant components (Fig. 10)

- Less susceptible to interruptions for planned and unplanned activities;
- Redundant components with single power supply and cooling system;
- Presence of UPS, generators and floating floor;

- Total shutdown during maintenance on power and other parts of the infrastructure

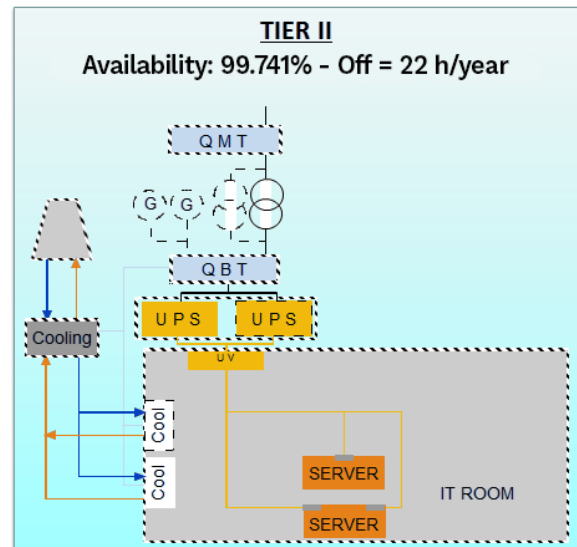

Fig. 10

Maintenance during normal operation (Fig. 11)

- Ability to carry out scheduled maintenance without interruption, but susceptible to interruptions due to unplanned activities;
- Redundant components and multiple connections for power and cooling;
- Presence of UPS, generators and floating floor;
- Total shutdown is not necessary during maintenance;
- Expected diversion to other connections for power and infrastructure.

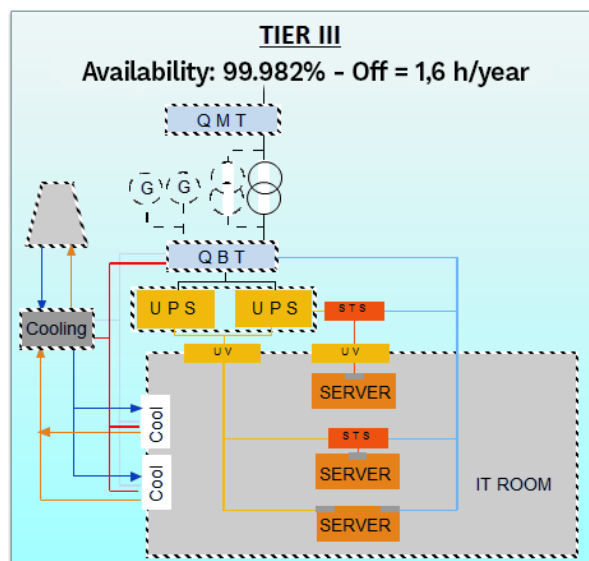

Fig. 11

Fail-safe power supply network (Fig. 12)

- Ability to carry out maintenance, planned or not, without impacting functionality;
- Redundant components and multiple connections simultaneously active for power and cooling;
- Availability of UPS, generators and raised floor;
- Total shutdown is not necessary during maintenance;
- Expected diversion to other connections for power and infrastructure.

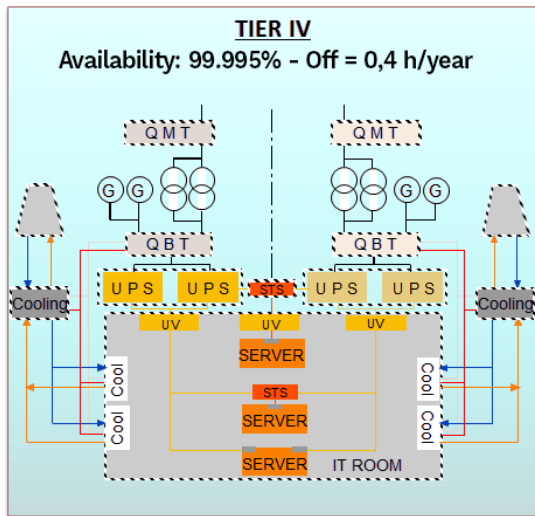

Fig. 12

Once you have established the power requirement and the type of structure you intend to adopt, assess the power and quantity of the UPS required.

For example, in a Data Center whose total power to be protected is equal to 200 kVA, a 200kVA standalone UPS could be installed in these configurations:

- Tier I: n ° 1 single 200 kVA UPS
- Tier II and Tier III: 1 system built with 2 x 200 kVA UPS, in N + 1 redundancy
- Tier IV: 2 single 200 kVA UPS, one for each radial.

If instead, the power was 1000 kVA, 500 kVA UPS could be installed in these configurations:

- Tier I: 2 UPS in parallel of 500 kVA
- Tier II and Tier III: 1 system built with 3 x 500 kVA UPS, utilising 1000 kVA of power in N + 1 redundancy
- Tier IV: 2 systems, one for each radial, each

consisting of 2 UPS in parallel of 500 kVA, to obtain 1000 kVA of power available on each radial.

TIER I → 99.671% - Off = 28,8 h/year

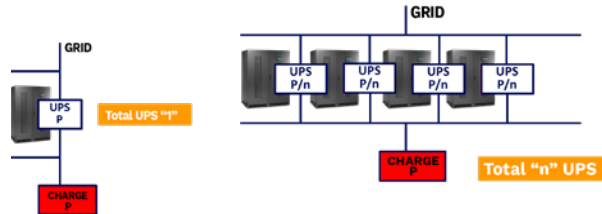

TIER II → 99.741% - Off = 22 h/year

TIER III → 99.982% - Off = 1,6 h/year

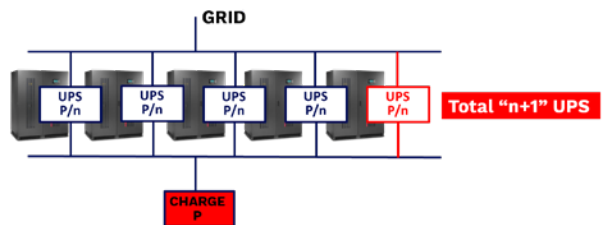

TIER IV → 99.995% - Off = 0,4 h/Year

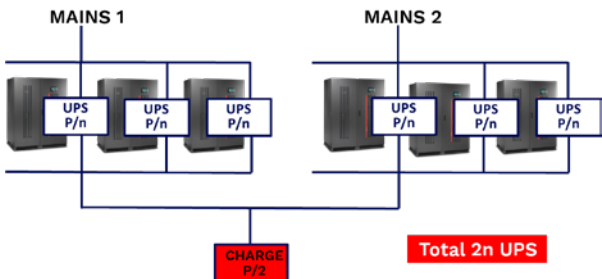

Type of UPS

The market offers two construction solutions: monolithic or modular.

- Monolithic UPS (standalone): characterized by a single power module sized for the maximum load power.
- Modular UPS: allows you to increase the power according to the increase in load, thanks to the possibility of being added or replaced when hot. The modular UPS also allow for N + 1 redundancy within the UPS, with great simplification of the system.

Scalability, “Pay as you grow”, Integrated N + 1 redundancy, Automatic load management, and efficiency optimization make this solution the most suitable for installation in data centers.

Type of batteries



Another important element to evaluate in the design phase is that of the battery necessary to provide the autonomy required for the critical load. Battery systems can be designed using various technologies, differing greatly in costs. Those with the best price/performance ratio, which consequently makes them the most frequently used choice, are the maintenance-free valve regulated lead-acid batteries (VRLA). They are divided by expected life, from 5 to 10/12 years and over 12 - up to 15 and 20 years. VRLA batteries can be installed both in a cabinet and on a dedicated battery rack, but since they emit hydrogen, they require ventilation with special technical precautions according to the EN 50272-2 standard.

The second type of batteries to consider is the lead-acid open vessel, which requires maintenance and periodic topping up of water. Even for this type, the expected life varies according to the model and makes it mandatory to set up special shelves and rooms with strict ventilation to dilute the hydrogen emitted. Another type is the open vessel nickel-cadmium batteries which typically require maintenance and water topping up, but some designs are very low maintenance. They can be installed on a battery rack and in some cases also in a cabinet, but usually require special rooms with ample ventilation, again due to hydrogen.

The last category of batteries is lithium-ion, capable of storing large amounts of energy in small spaces and with very fast recharging, about 10 times faster than the previous examples. They have electronically controlled modules (BMS) and can be installed within a cabinet without the need for ventilation.

The installation of the UPS

The process leading to the installation of a UPS involves many decisions. Below we analyze the main alternatives faced by those who have to supervise this process.

Modularity - The choice between monolithic technology or modular technology has significant repercussions both on the flexibility and on the economies of the system.

Parallel - Connecting several standalone systems in parallel operation can often be an efficient way of achieving a higher total power rating whilst still maintaining redundancy.

Radiality - Is it advisable to adopt double radial systems, with UPS systems that could be identical, independent for each radial, placed in separate rooms? In this regard, it is important to consider that in double radial systems there may be single supply loads; should it be necessary to cover them with redundant systems, everything should be equipped with a UPS synchronization system of the two radials, to better manage the phase switching activities between one radial and another.

Power supply - It is advisable to adopt a single line power supply or, where the UPS allows it, a dual input, one for the rectifier input and one for the bypass input (alternative input to power the load in case of failure of inverter)? The dual input allows separation of the fault circuits; risks for operators could arise from the static bypass switch inside the UPS which could be subject to an energy return fault, with power supply to the upstream line; for this the UPS provides an alarm contact to be interfaced with a release coil of the bypass line protection switch or with a contactor. Providing dual inputs, in case of energy return, is useful for maintaining supply to the critical load.

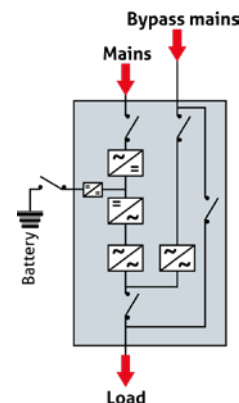

External bypass switches - Having this type of device certainly facilitates easier maintenance. In particular, if the UPS has an internal maintenance bypass disconnect switch and if the architecture includes a single UPS or two redundant parallel UPSs, the choice of inserting this switch in the system is free.

If, on the other hand, the UPS system is made with two UPSs in parallel or more than two UPSs regardless of the architecture, the internal disconnect switch cannot be used, and therefore the external switch becomes a necessity. The improper use of an external maintenance bypass switch can cause serious problems. It is recommended a security system that prevents access to those who are not authorized (lock with key, padlock, combination or other) is provided alongside a procedure for its correct use and the addition of an output disconnecter for each UPS.

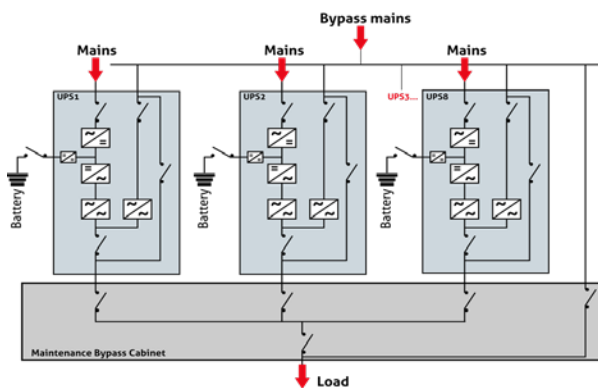

Differential switches – They can be provided upstream or downstream of the UPS. If they are downstream, the sizing depends on the characteristics of the load and the system, while if they are upstream, the UPS is transparent for earth leakage currents and therefore it is necessary to add up the current values of the load and the UPS.

According to the EN 62040-1 standard, type A is envisaged for UPS with single-phase input, while type B is for those with three-phase input. Finally, only devices for indirect, selective or delayed contacts can be used. Generally speaking, in a TN-S system the UPSs do not require upstream differential protection; the designer can also decide otherwise. In either case the differential must be positioned upstream of the power supply lines if the UPS is single (therefore the differential must be located on the common electrical node, downstream

of which two thermal magnetic switches must be placed for the two input lines); in the case of parallel UPSs, the differential must be provided upstream of all the power supply lines of all the UPS inputs, including any external maintenance bypass switch.

Additional transformers - They can be installed on the input or output of a system, for example to recreate a TN-S system. However, it must be considered that the transformers add heat dissipation and create an inrush current at start-up meaning the protection switch upstream of the primary of the transformer and/or the static bypass switch inside the UPS must be able to sustain this inrush current. Furthermore, they affect the short-circuit and earth fault currents downstream of the secondary, and this must be taken into account in the design, execution and testing phases.

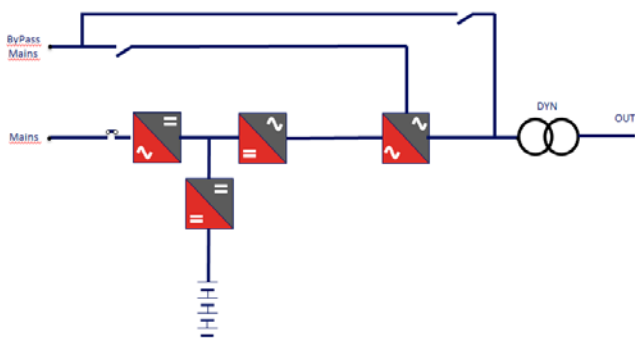

Generator - It may happen that in a system the position of the UPS is provided downstream of the generator (grid / GE exchanger); in this case, it is necessary to take into account various factors such as the maximum input current absorbed by the UPS, the inrush current of the UPS when the rectifier is powered up again, the harmonic distortion current values, the power factor of the UPS rectifier, the value of the sub-transient reactance of the alternator, the possibility of inhibiting battery recharging on the UPS when it is powered by the generator, the possibility that the UPS has a ramp current draw at the rectifier input and, in the case of several UPSs in parallel or multiple UPS systems, the possibility of delaying the rectifier start-up in a different way for each UPS. It is also necessary to evaluate whether the UPS is able to operate with loads with high power factor, from 0.9 to 1.

High power factors - It is necessary to evaluate whether the UPS is capable of operating with high power factor loads, from 0.9 to 1.

Interfaces - The UPS is a device that must now be fully integrated with a much wider system and for this it must be equipped with information interfaces such as alarm contacts, SNMP, MIB, Web Browser, Modbus, Bacnet and many more. Establishing the type of remote supervision protocols required is vital.

THE ROLE OF UPS IN TERMS OF ENERGY EFFICIENCY OF DATA CENTERS

The energy efficiency of a Data Center is identified by the PUE (Power Usage Effectiveness) which indicates the ratio between the overall electricity consumption of a data center (both Information Technology equipment and air conditioners, fans, UPS, etc.) and the consumption of only IT equipment. 1.0 is the optimal theoretical value, where all the energy absorbed by the system is used for the IT equipment

PUE

Power Usage Effectiveness:

[Total Data Center energy / Energy consumption of the IT equipment]

(Reverse of: DCiE - Data Center infrastructure Efficiency)

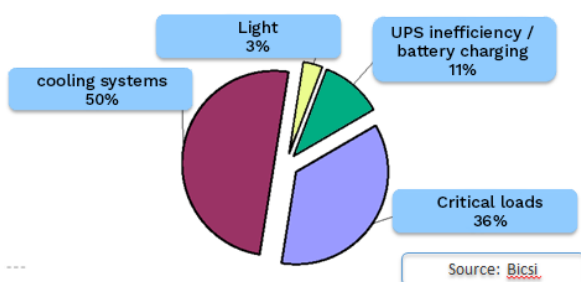

UPSs play a fundamental role in energy-saving policies in Data Centers and to achieve these objectives, they must guarantee ever-higher levels of efficiency, thus significantly reducing energy consumption.

To optimize efficiency and minimize losses, modern uninterruptible power supplies use the most advanced technologies applied to both components and operating modes.

Regarding the components:

- **IGBT (Insulated Gate Bipolar Transistor)** (Insulated Gate Bipolar Transistor) of the latest generation with NPC2 technology at three levels for both the rectifier and the inverter;
- **Power modules** developed according to the “wireless power” principle in which the lengths of the connections between the boards, power components and connectors are reduced;
- Controlled and reduced **fixed losses** (e.g. fan speed control) to increase efficiency even at low loads ;
- **Maximum efficiency optimization** for loads between 50% and 75% of the rated power where the UPS most typically works;
- Possibility of powering the load from the upstream network, VI and VFD modes, with continuous control of the network quality and fast switching times, increasing efficiency by up to 3 percentage points compared to VFI mode (Eco and Smart mode);
- The possibility of using UPS in parallel with inhibition of the excess UPS in the event of low loads and rapid restart in the event of an increase in the power required by the load (Energy Saving).

A further possibility of saving can be linked to the use of modular UPS, as:

- The initial cost can be reduced by using only the minimum number of modules required for loading;
- The use of the minimum number of modules allows them to operate at the point of maximum efficiency of the converters;
- They allow the power modules to be added later, only if necessary, following the growth of the load over time
- They allow the inhibition of supernumerary modules in case of low loads
- They allow hot replacement/repair of faulty modules, while the load is powered continuously and in total safety
- They simplify and speed up maintenance
- They can be equipped with one or more redundant modules, eg. $N + 1$, where N is the total power of the minimum number of modules needed to power the actual load

As described above, the type of operation, construction, installation and maintenance of the UPS guarantees the correct power supply of the load, with high availability and safety and also

allows a global approach to the Data Center, with local and remote control of the system and a significant energy saving.

UPS MAINTENANCE - POSSIBLE PROBLEMS

Proper and scheduled maintenance of the UPS is essential for the prevention of failures and to minimize the risk of fault, which, if they occur, could turn into serious problems or worse still unsolvable disasters for business continuity with all its direct and indirect consequences. Maintenance is often neglected or in some cases almost impossible to achieve without downtime to the load, due to poor system design (i.e. no maintenance bypass switch).

Maintenance has two crucial aspects:

- must be carried out by specialized personnel
- must be managed upstream by those who have a strategic vision of the plant as a whole, including its future evolution.

The maintenance manager must be able to efficiently maintain the UPS system. This may be in an ad-hoc way where he acts 'on demand' for each fault, or in a more managed way, with an organized maintenance contract, where preventative maintenance visits and any necessary repair work are planned in unison with the UPS supplier. Finally, the maintenance manager can decide to choose to have proactive monitoring of the UPS system via remote UPS monitoring systems. **Periodic maintenance or remote monitoring?** Although they can easily coexist and integrate, they are still two different ways of ensuring the proper functioning of the UPS.

Periodic maintenance requires that one or more checks are carried out during the year to assess the correct operation of the equipment, perform cleaning, replace auxiliary components (eg fans), update software or hardware.

Remote monitoring, on the other hand, is carried out by connecting to the UPS and provides the information on its operation directly to the control center of the UPS manufacturer.. Data from external and internal events that the system collects allows the UPS itself to launch emergency calls to the support technician, imultaneously providing valuable information on the fault. This allows the UPS technician to arrive on-site prepared with the correct spare parts required to repair the UPS.

Riello UPS maintenance service

Riello UPS provides its customers, direct and indirect, with numerous structured assistance services. In particular:

- **Pre-sales consultancy**

Our TEC (Technical Energy Consultant) experts have been working in the power sector for years. They come from a range of backgrounds and enjoy a wealth of technical experience in sectors such as Data Center, Industry and Power Plants. By adopting a consultative, honest approach, our engineers and technicians support customers to achieve the perfect outcomes in power quality and power protection for their business. The TEC Team keeps up-to-date regarding the latest trends in energy management and energy infrastructures. This means they have a deep understanding of the latest energy efficiency technologies including Smart Grids, Cloud and IoT energy requirements, Energy Storage aimed for Demand Response (Frequency Response or Peak Shaving), Supercapacitors, and Lithium solutions.

Consultancy on standards - Our TEC Team provides professional support to help customers comply with all necessary regulations (UNI, ISO or UL CSA standards), and related requirements, including the issues of energy management and safety protection.

Furthermore, the TEC Team's energy management expertise is aided by ongoing discussions with Riello UPS's Research and Development department, which is always aware of the latest regulatory standards. Whatever your need, our TEC Team will help you to find the most effective solution.

The TEC Team can provide exhaustive information concerning:

- Special appliances with particular IP ratings (e.g. IP30, IP31, IP41, IP42);
- Special treatments that enable UPS to perform in tropical conditions or to withstand the effects of earthquakes;
- Tailored systems providing optimal CapEx and OpEx;
- Customized solutions with a "pay as you grow" approach.

In addition, the TEC Team provides standard regulatory consultancy concerning:

- Products and portfolio solutions;
- Batteries, flywheels, supercapacitors, lithium solutions;
- Installation and configuration;
- Applications (Data Center, emergency lighting, electro-medical, railways etc.).

Work tools - Training and information The TEC Team can provide extensive documentation and work tools including:

- UPS sizing;
- Official technical guides;
- Installation requirements;
- TEC newsletters and training webinars;
- Technical specifications;
- Technical presentation;
- On line tools (TEC area, UPS

configurator, Riello Toll Box (runtime calculation), etc..

Technical seminars -The TEC Team stages regular technical seminars and training sessions. Customers, engineering firms, and sector associations can also request for specific seminars to be staged on-site or at suitable locations.

Design support - IThe TEC Team can provide technical assistance concerning the recommended choice, sizing and installation of our complete range products and solutions.

Help Desk - TEC Team support is available by phone or email. We guarantee a response to any query as soon as possible..

FAT- Factory Acceptance Tests

(Witness Test) - The Factory Acceptance Test (FAT) is a process that evaluates the equipment after the assembly process by verifying that it is built and operating in accordance with design specifications. It consists of a variety of inspection points and tests per the request of the customer, based on their requirements or unique equipment specifications.

In general, an FAT covers:

- **Comprehensive inspection** – based on the equipment and the requests of the customer. This can also include a range of conformity checks and verifications;
- **Contract audit** – a review of the original agreement to make sure all contractual obligations are met;

- **Operational test** – this procedure simulates the system in operation to provide proof of functionality. During these tests the system is analyzed both in static and dynamic conditions, so to validate the declared performances and the customer's expectations. These tests also include verification of all relevant supporting documents, including user manuals, P&IDs and any type of instructions that come with the equipment to make sure they are accurate.

All inspection and testing is done at the state-of-the-art Riello UPS facilities in Legnago and Cormano. Riello UPS technicians and members of the TEC Team accompany customers and oversee all the tests.

• **Technical assistance**

The Service Team: guaranteeing the performance and quality of our products over time -

The proven quality and reliability of Riello UPS products is complemented by unmatched after-sale service. By adopting a highly professional approach, our engineers and technicians provide reliable and qualified technical support that enables our customers to promptly solve any problem that may occur to their power protection systems.

In addition, the Service Team's ability to analyze data from the UPS encourages preventive, predictive or corrective maintenance. In this way, any necessary interventions can be scheduled cyclically, minimising the likelihood of a fault and enabling prompt intervention in the event of sudden problems or unexpected anomalies. From electrical installation and commissioning to ongoing maintenance and product training, our Service Team is constantly committed to achieving the target of zero downtime of the installed Riello UPS power continuity solutions and lead the customers into the future of the real-time energy management.

The services Our Service Team provides customers with:

- A call center to have direct and immediate contact with the Service department. These technical staff are available to provide expert advice on the installation and maintenance of the equipment;
- The swap service for small UPS;
- The on-site technical assistance service

for larger non-transportable UPSs, whether they are under warranty or post warranty. Rapid interventions are made possible by the design concept of our products, by the professionalism of the Service Team personnel and by the well-established distribution networks in each territory;

- The on-site service for replacing exhausted batteries and the procedures for transferring them for safe and proper disposal;
- Preliminary site inspections to ensure the installation rooms are suitable, followed by commissioning of the UPS, including the initial

- start up, to ensure it is fully functional;
- Bespoke preventive maintenance contracts tailored to the customer's specific requirements;
- Riello Connect remote monitoring which analyzes the operating status. The technical team is always on-call to provide an immediate response to any alarm notifications.

These are the main services that Riello UPS provides to ensure maximum protection of the power systems and after-sales peace of mind.